

CONTENTS | 目录

01 | OVERVIEW

02 | LANDSCAPE

03 | HONORS

01



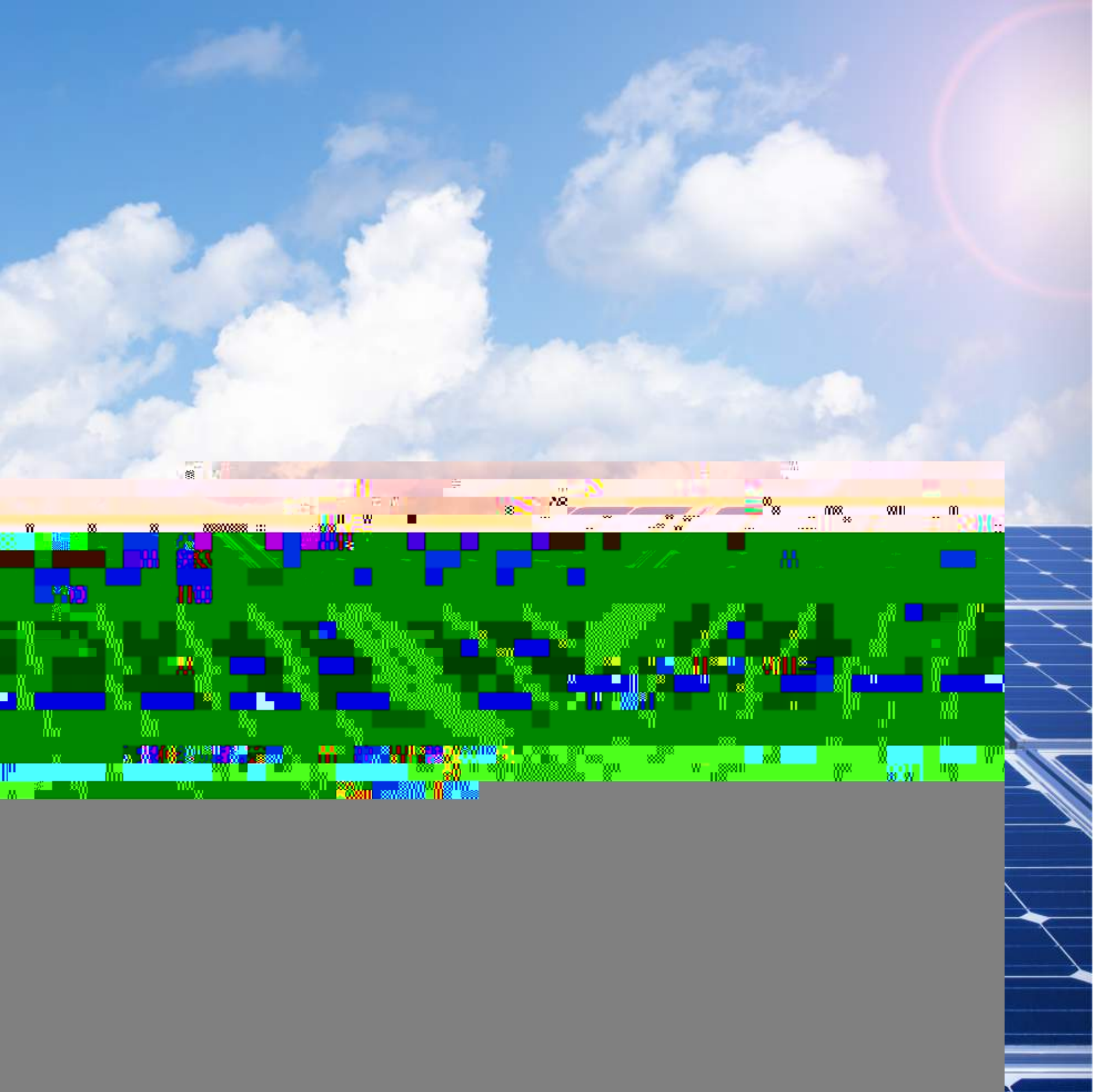

SZ300345) 1995 2012

(PIP)
N HJT

N

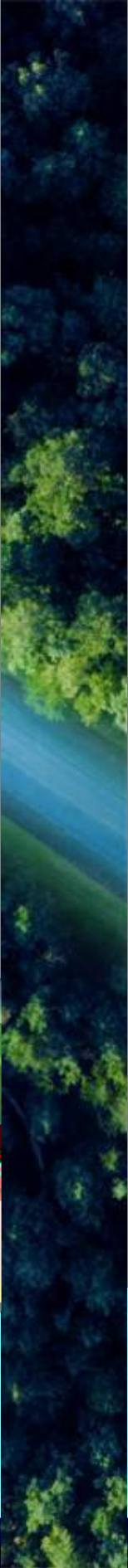
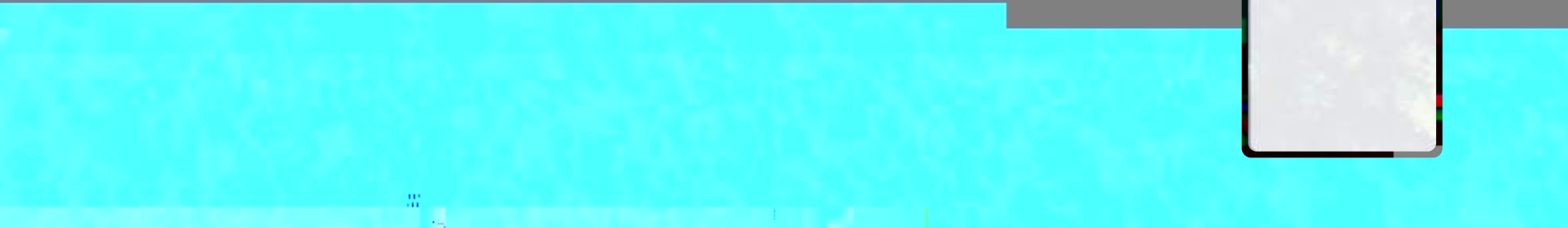
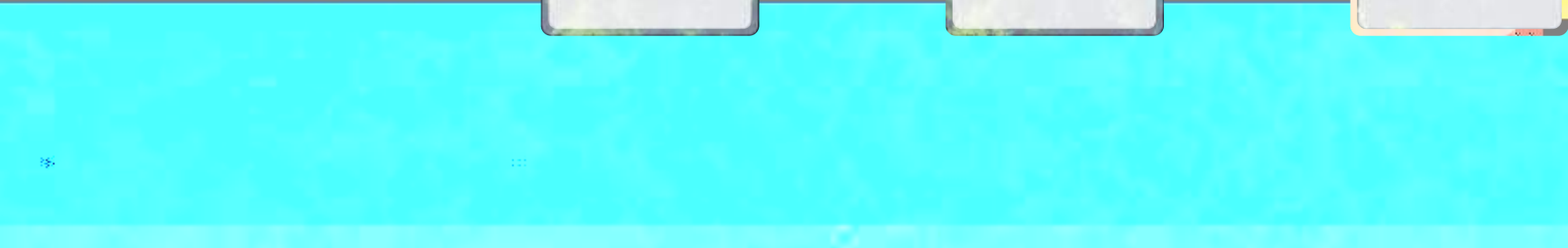
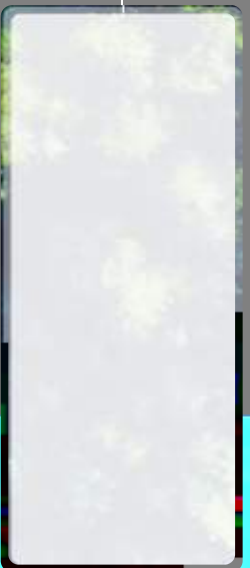
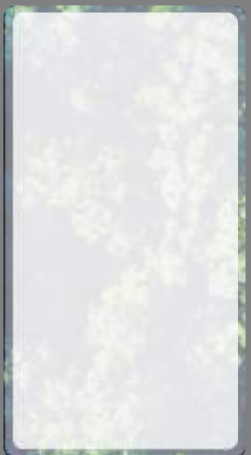
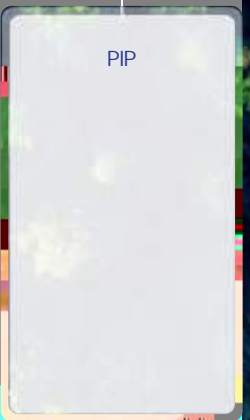
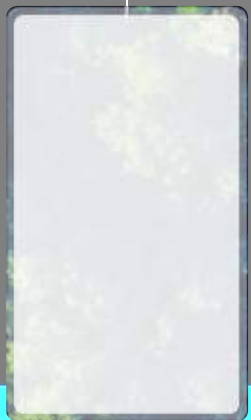
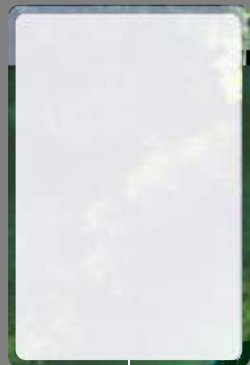

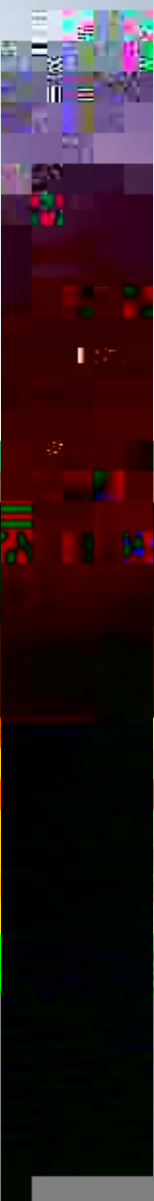
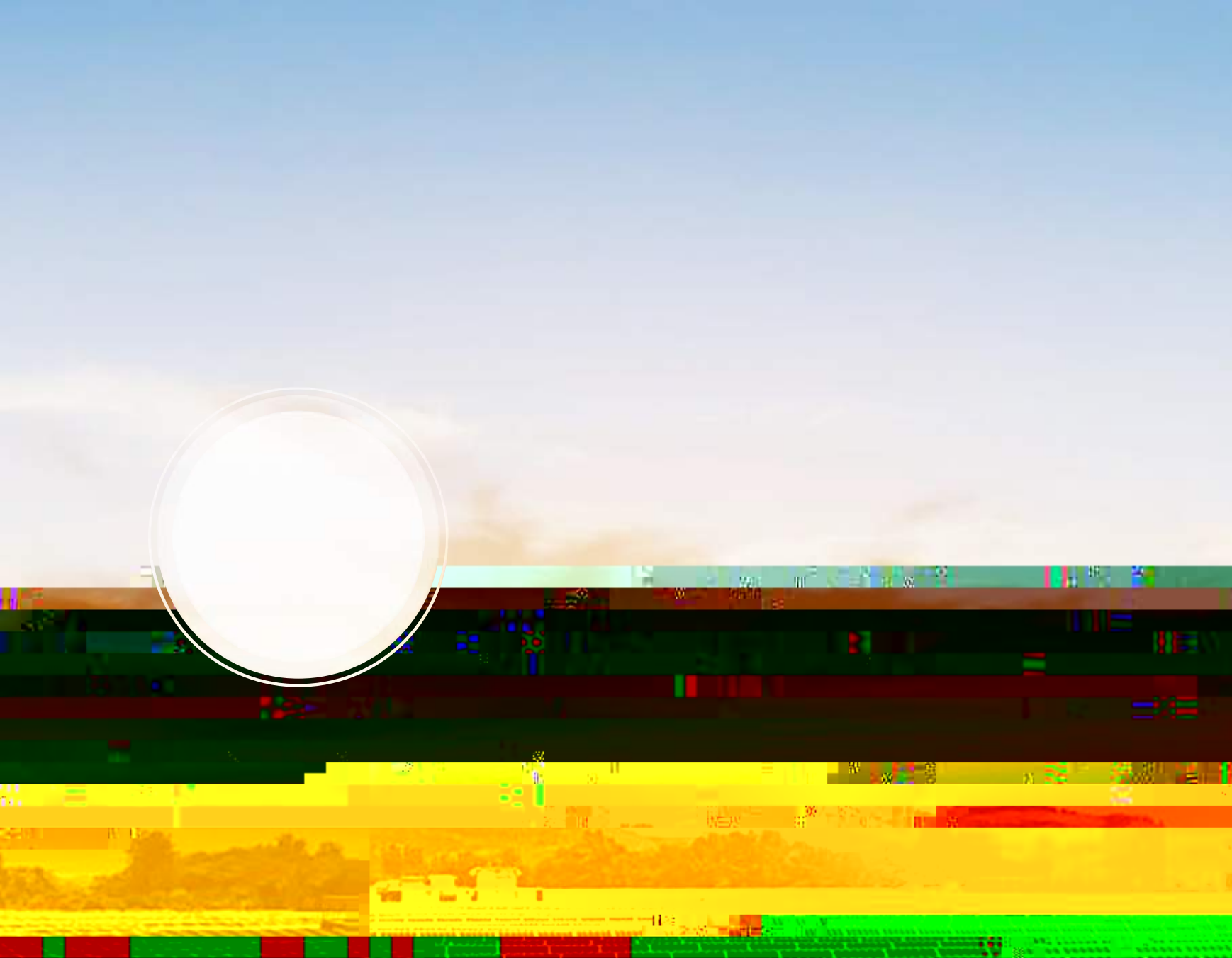

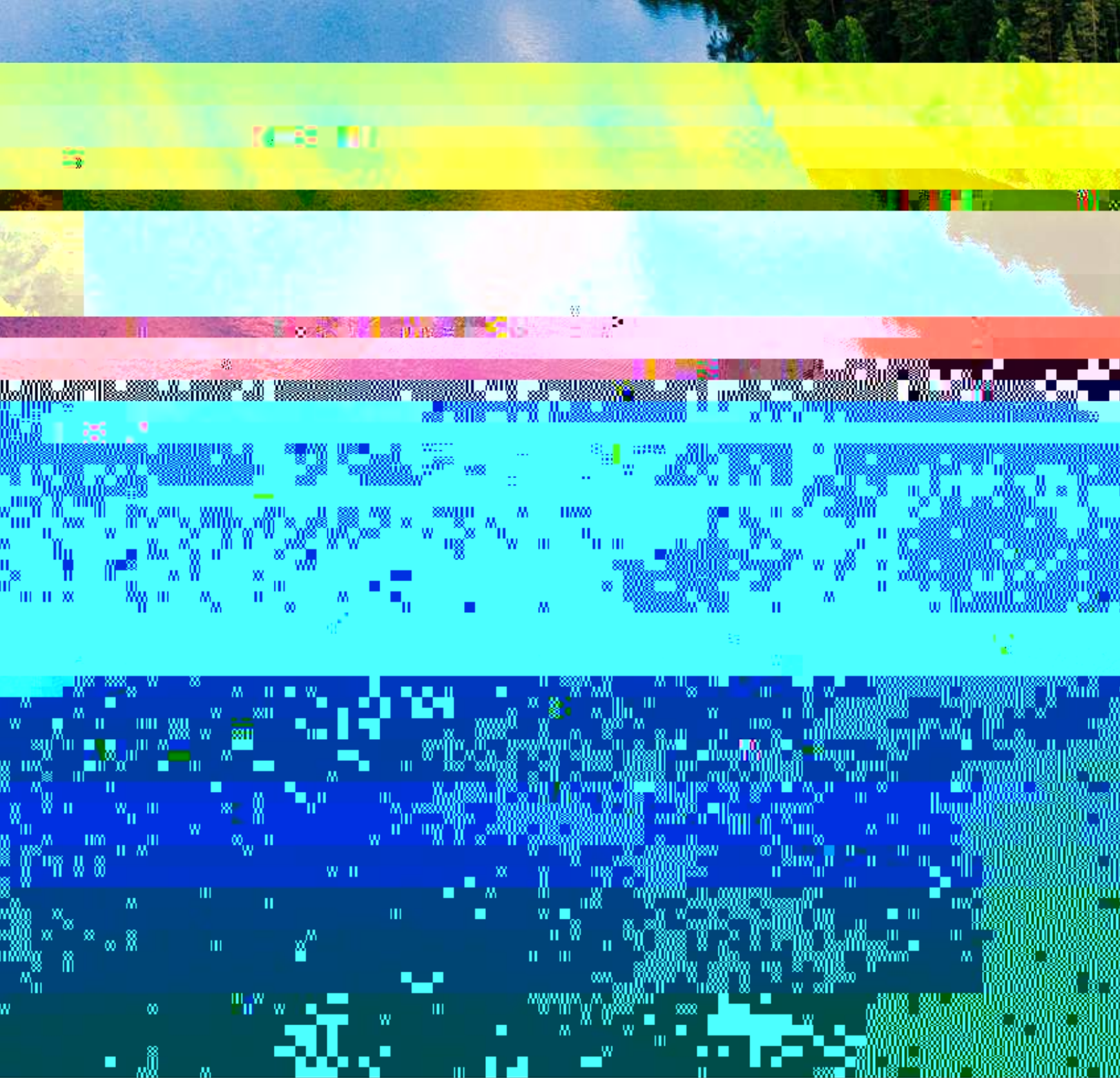

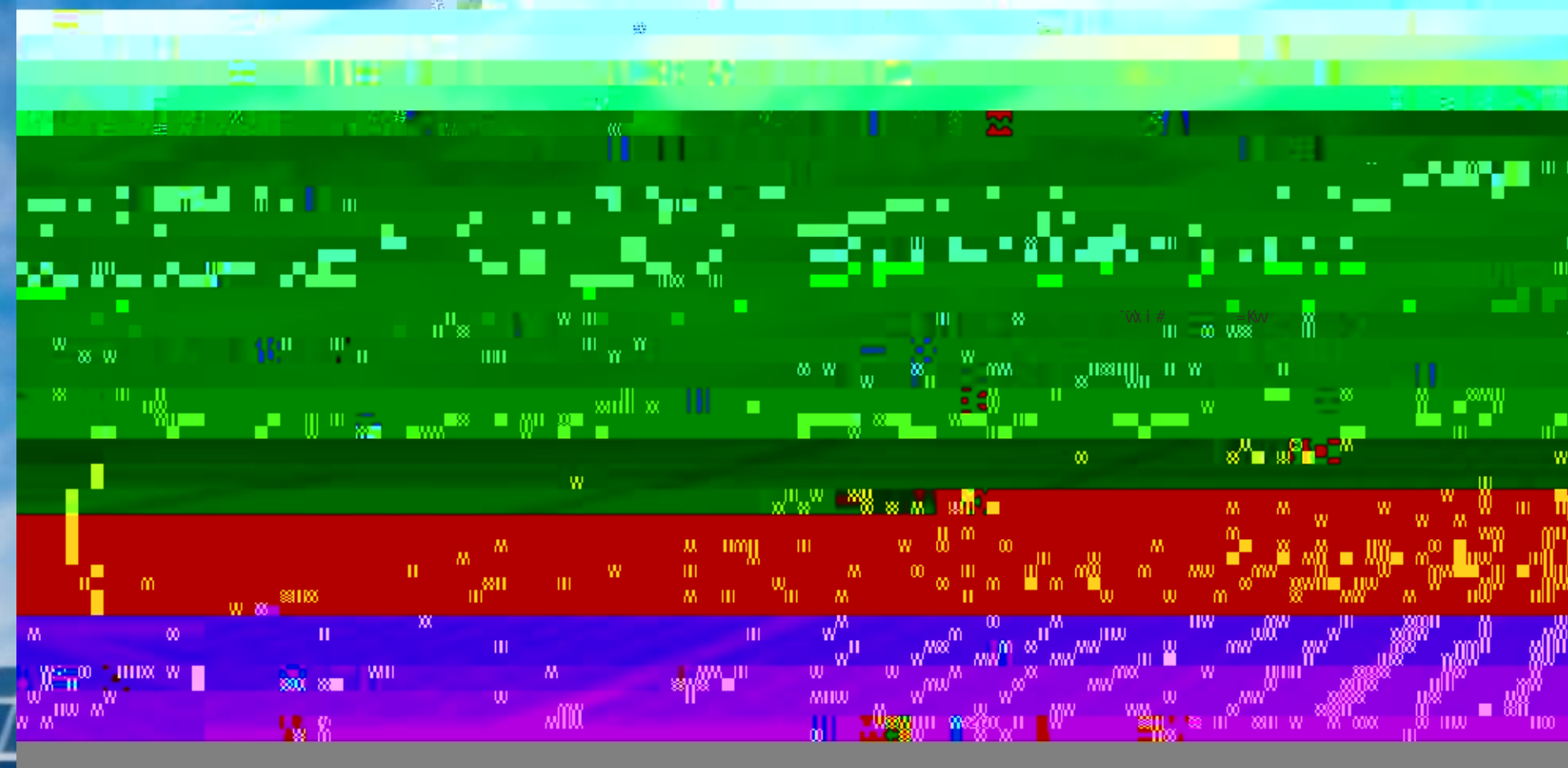
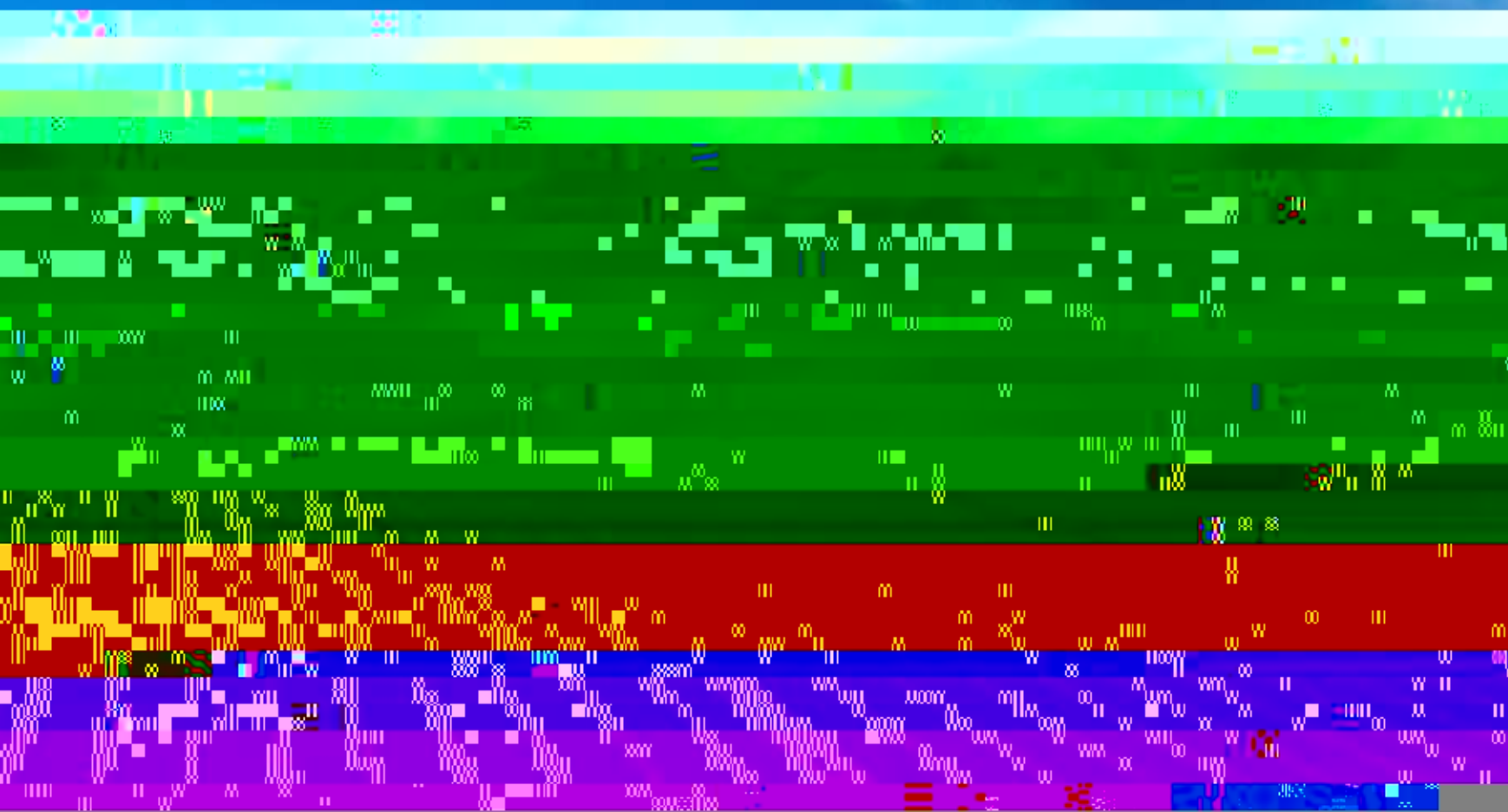

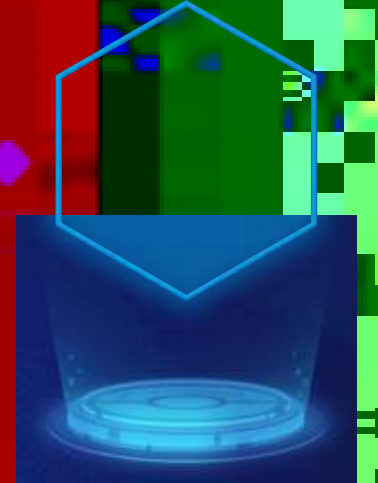
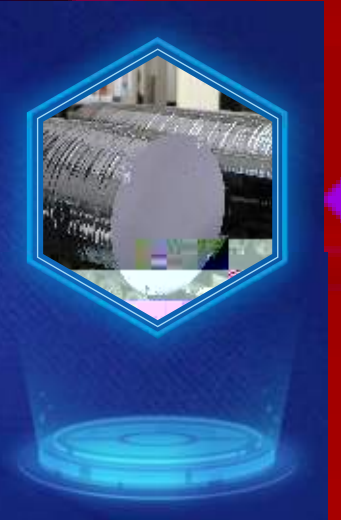

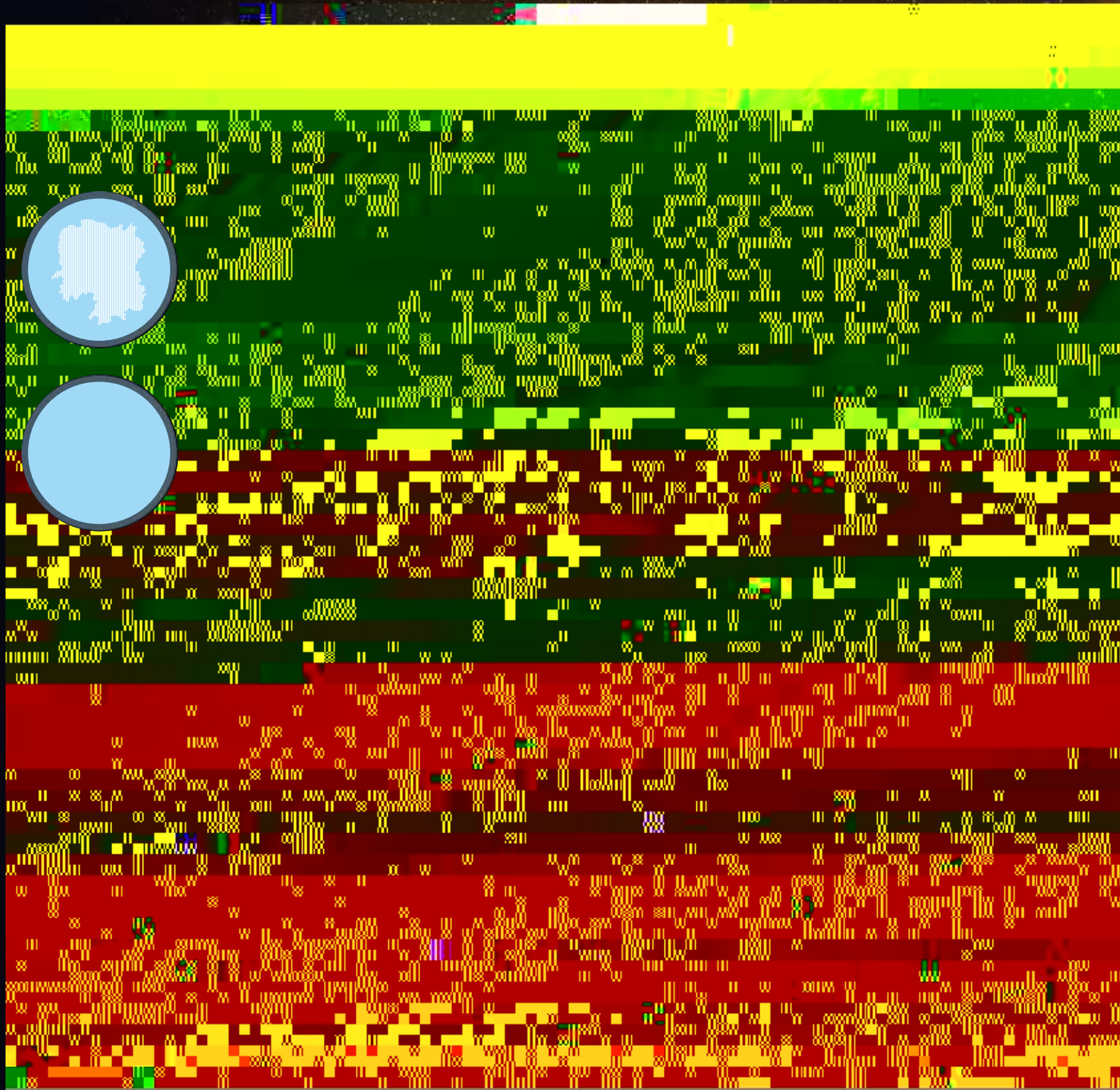

—

SZ300345

N

2022 1



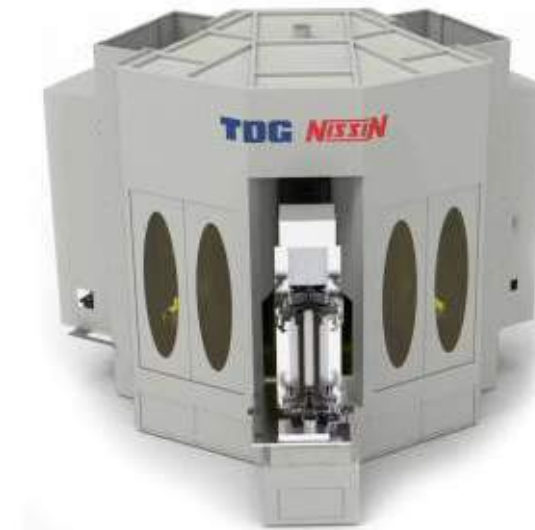
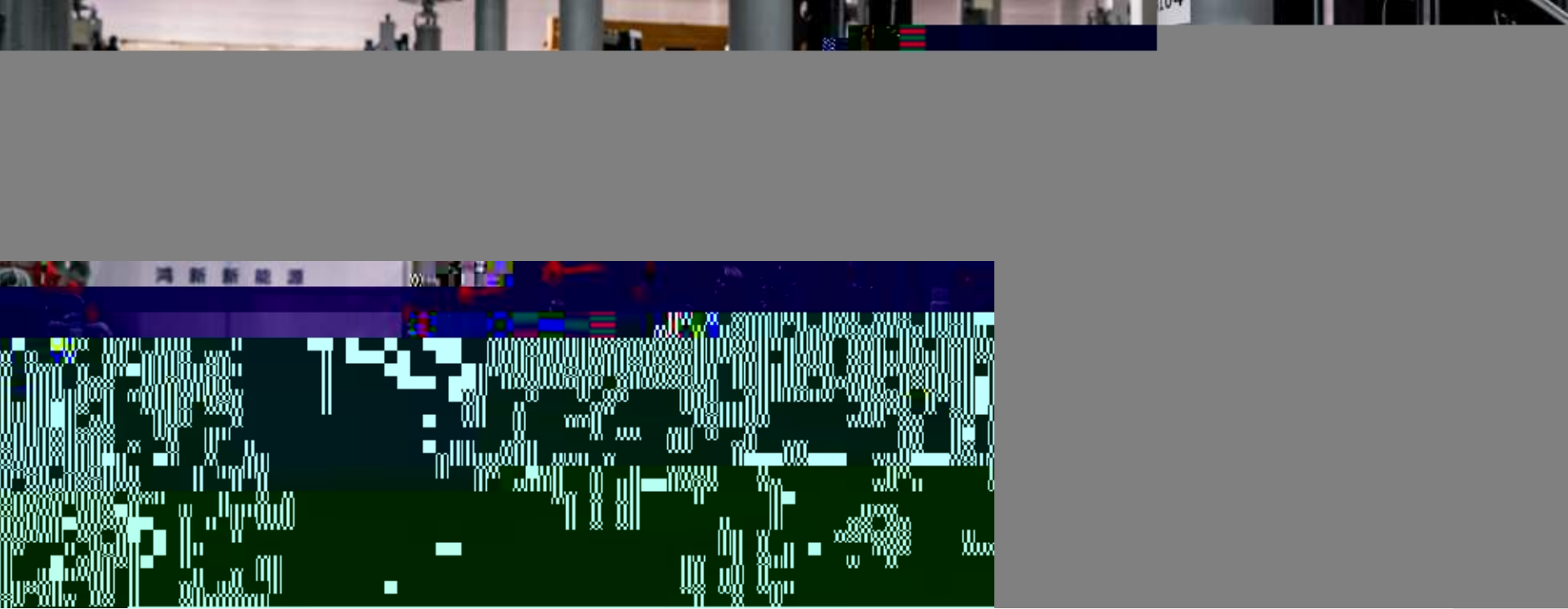

950mm

6500mm

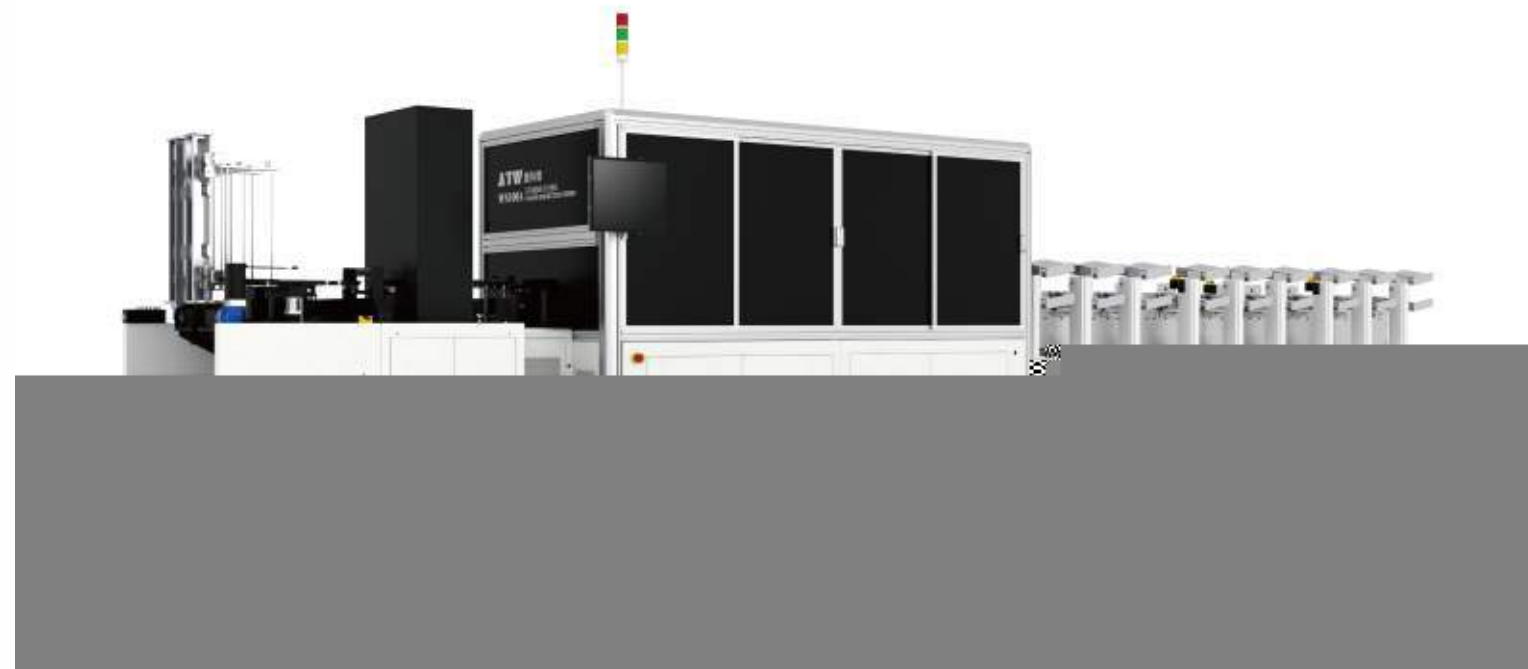

900mm
0.25mm



1600



3

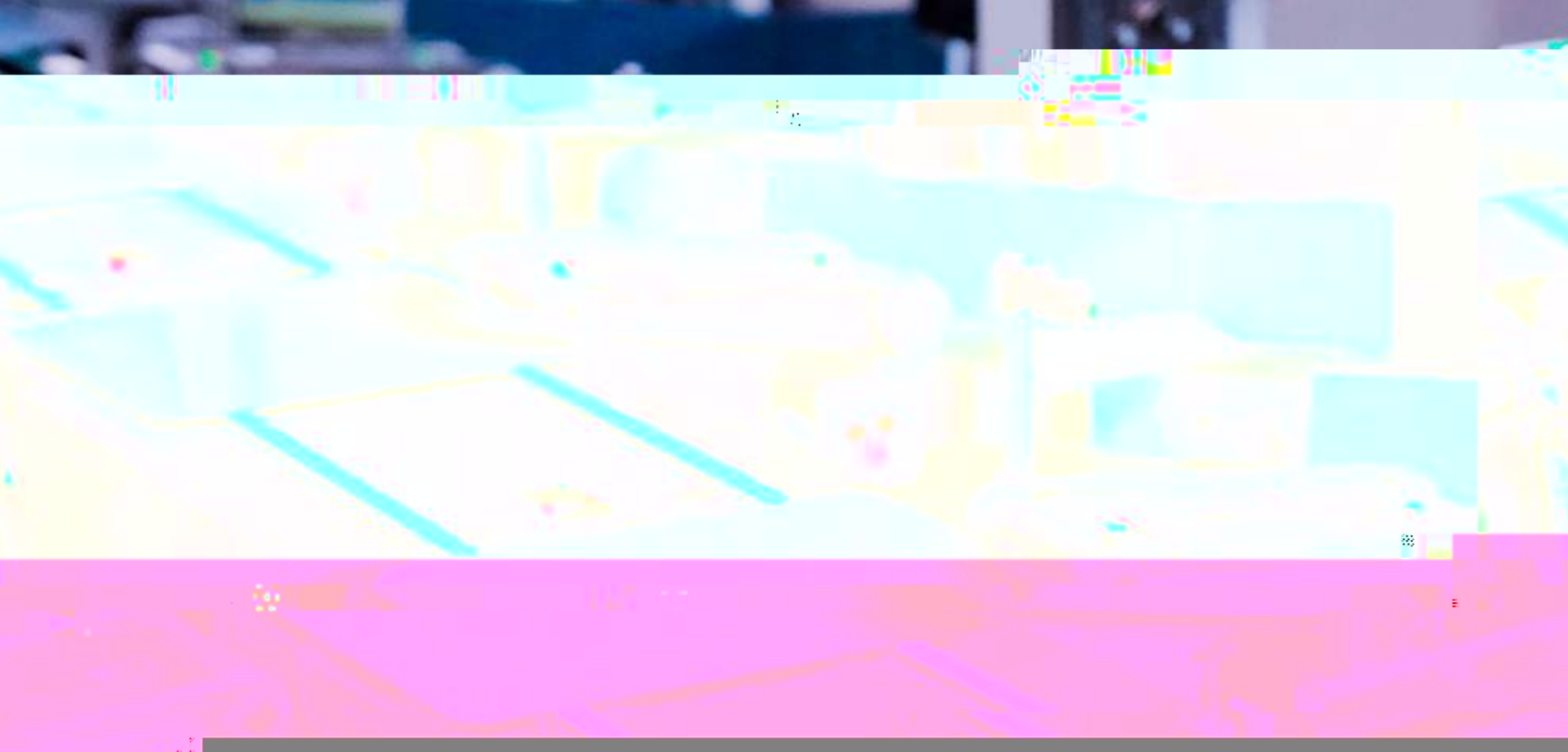
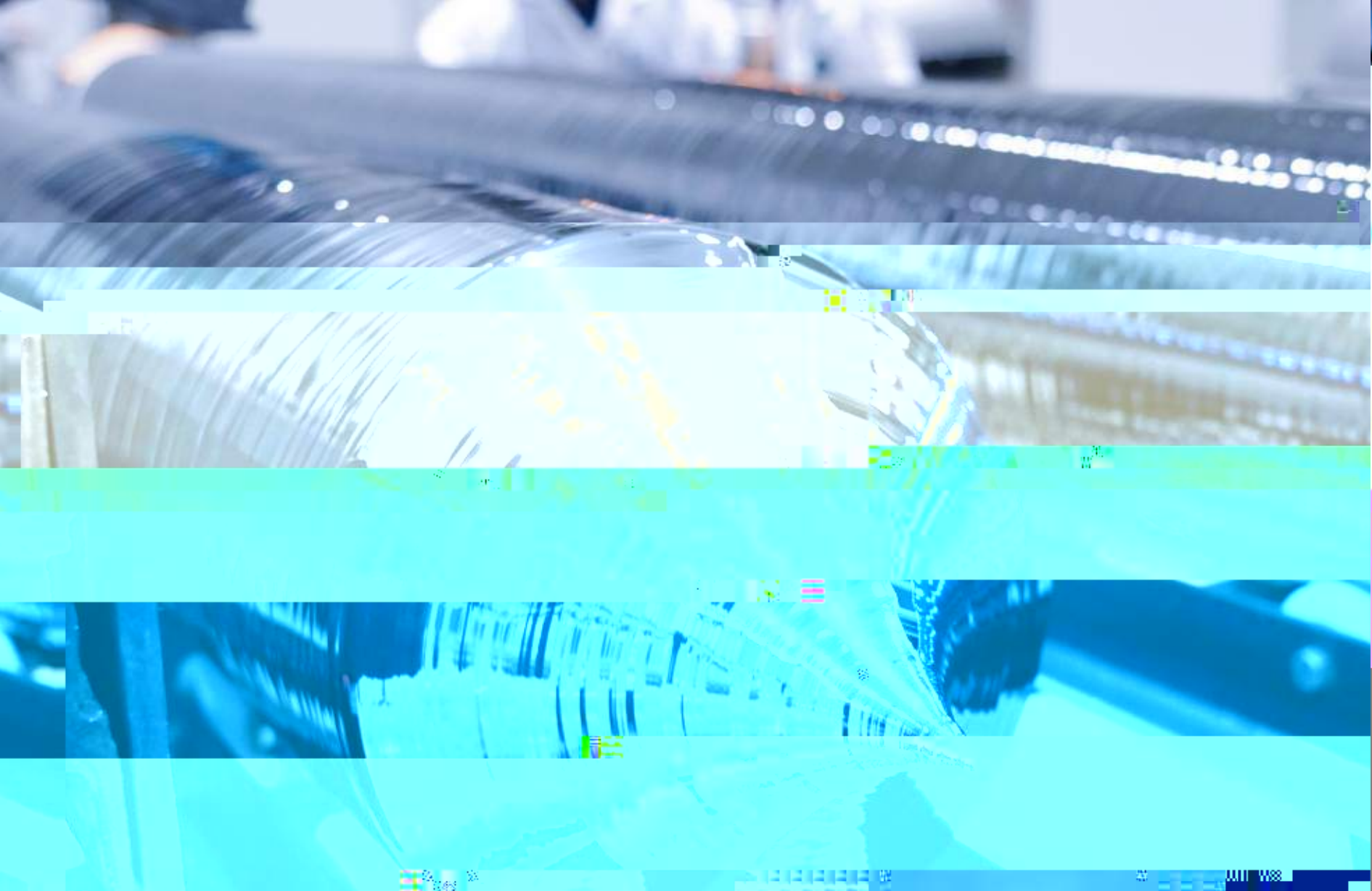

N



v



100%

P



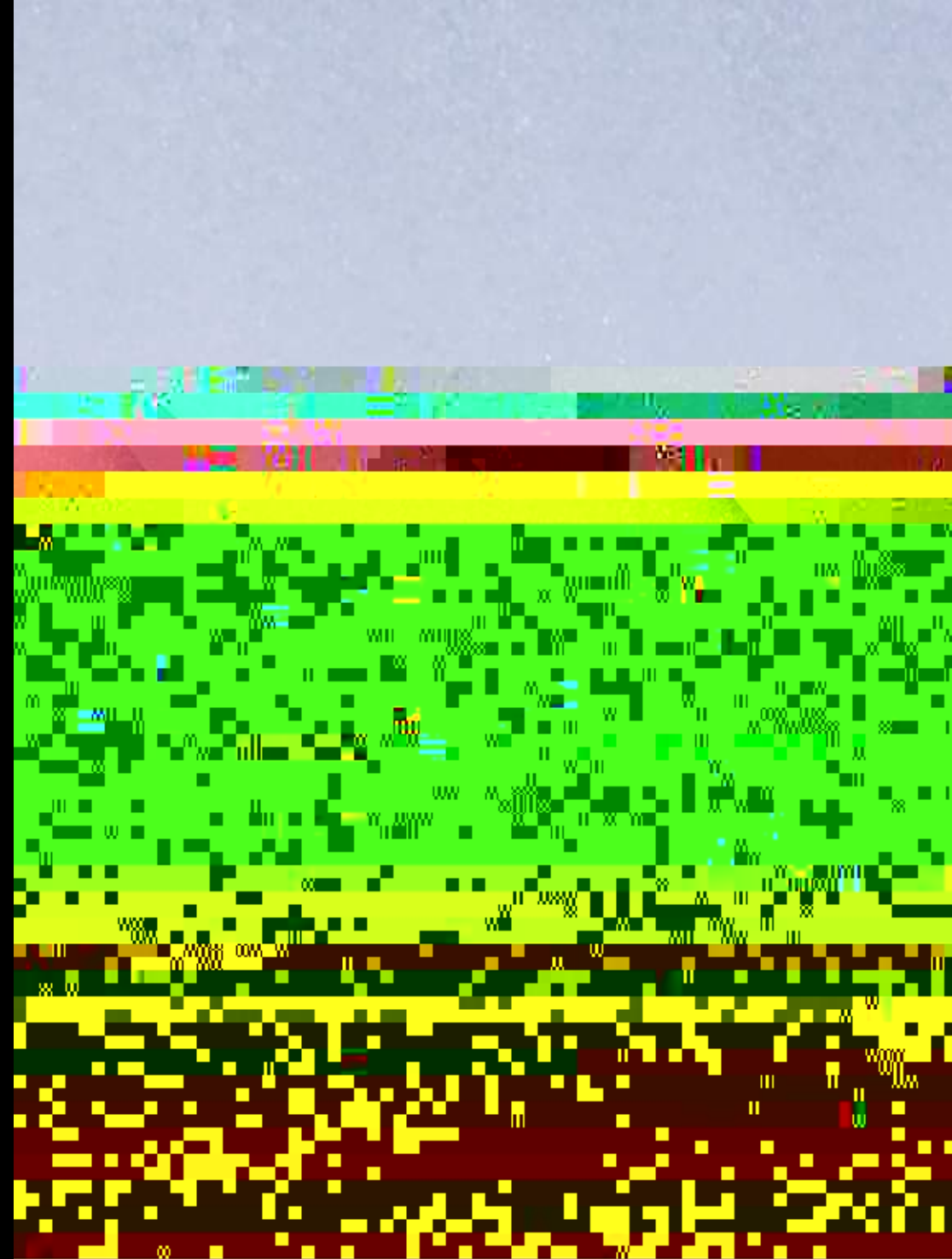
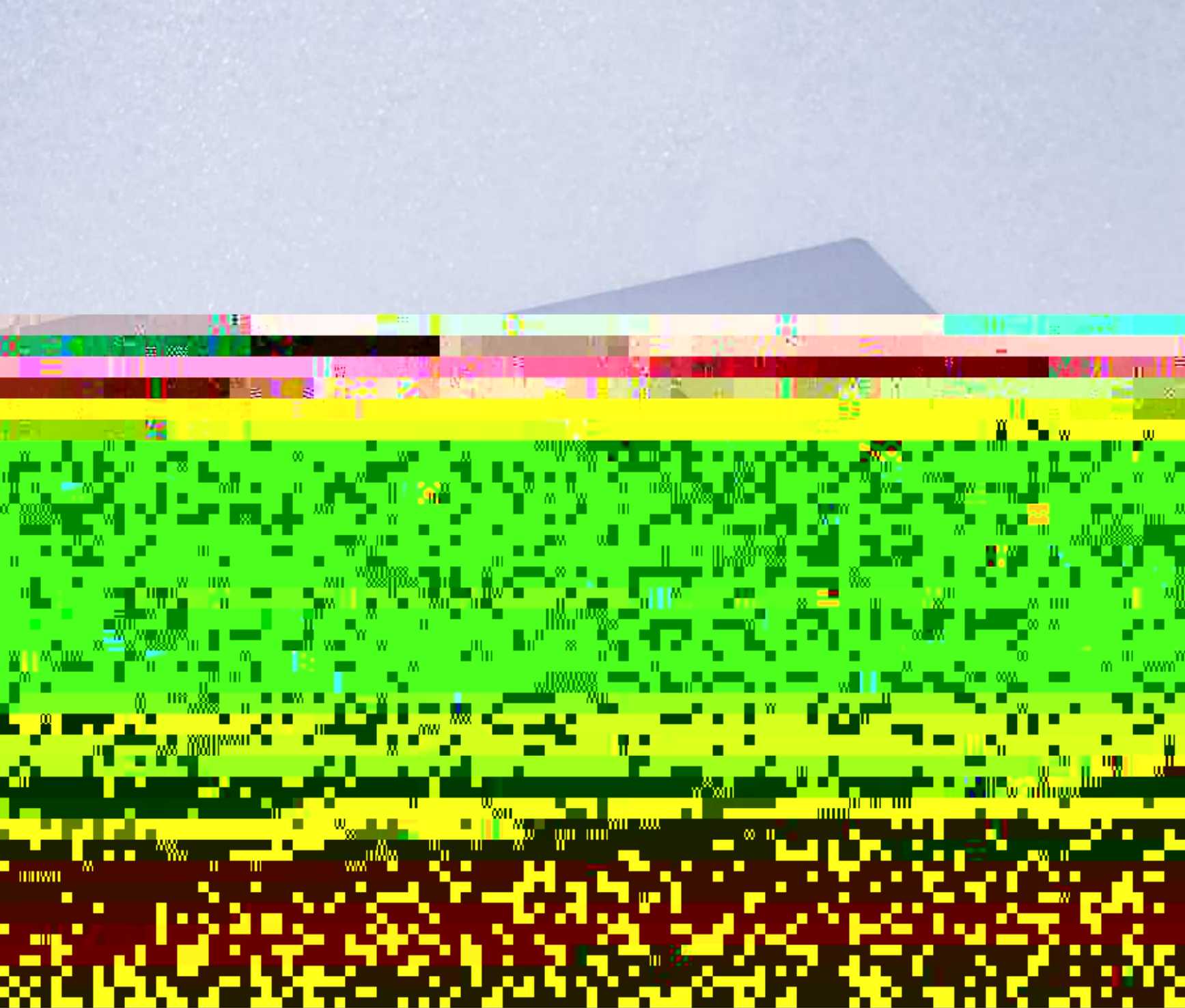

675W
12BB(210mm)

HS-M10/108H
HS-M10/120H
HS-M10/144H
HS-M12/120H
HS-M12/132H

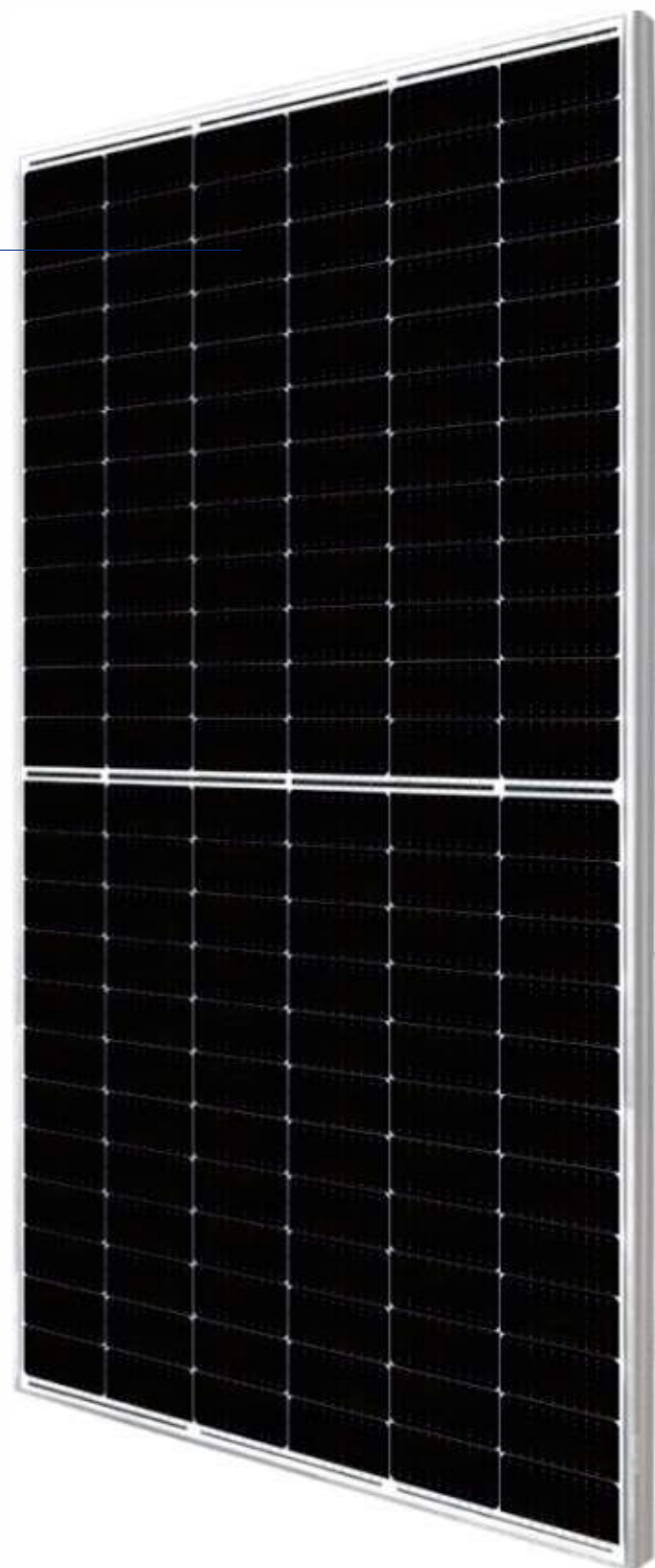

675W
12BB(210mm)

HS-M10/108G
HS-M10/120G
HS-M10/144G
HS-M12/120G
HS-M12/132G



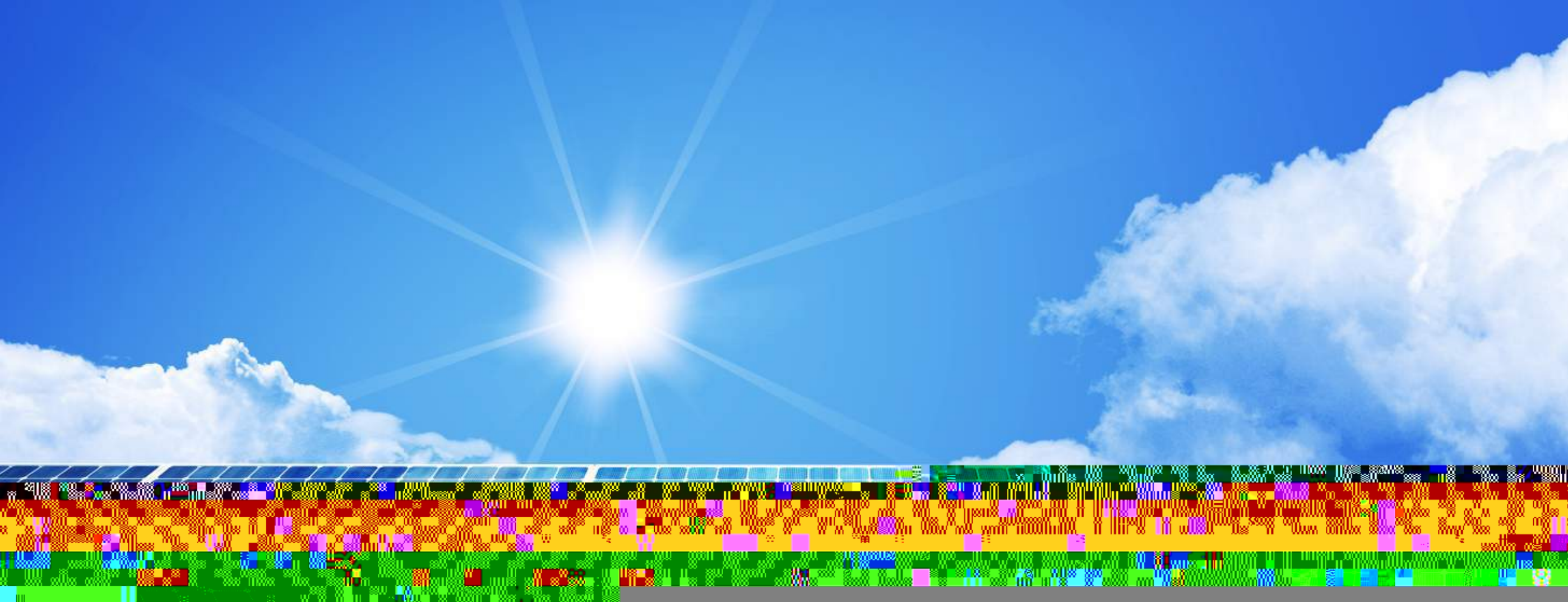

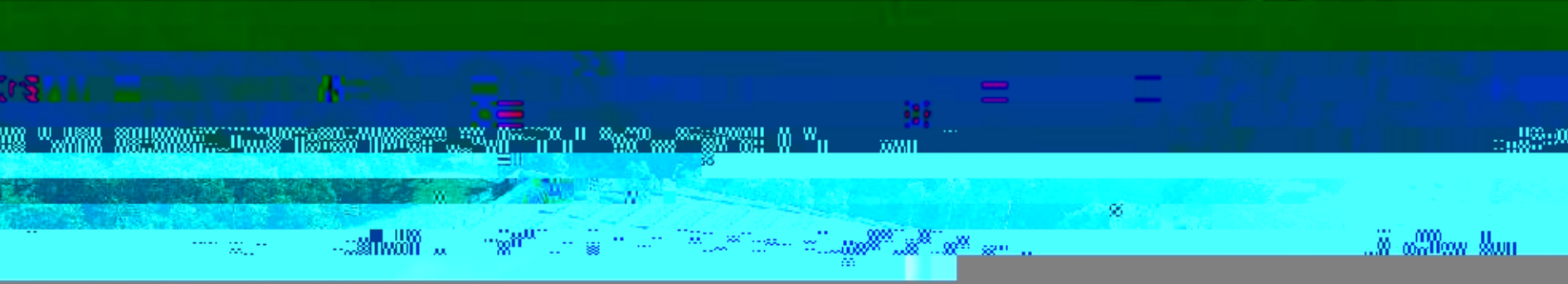
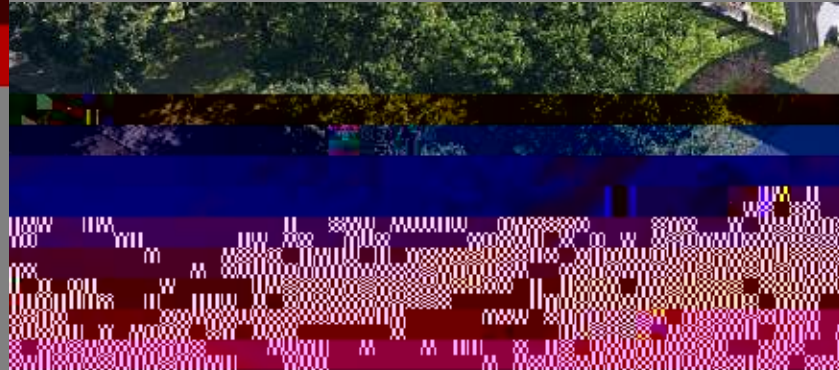
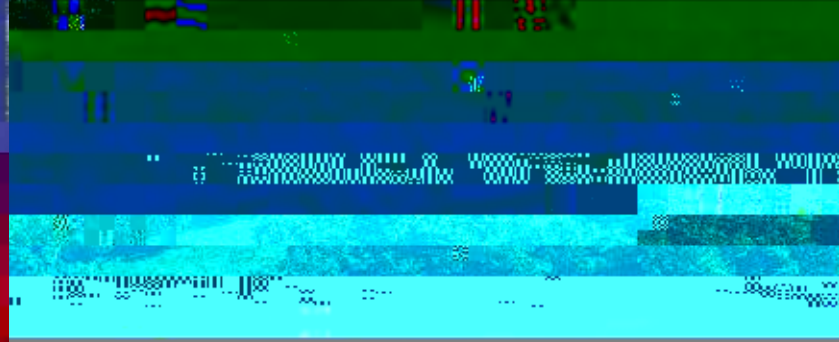

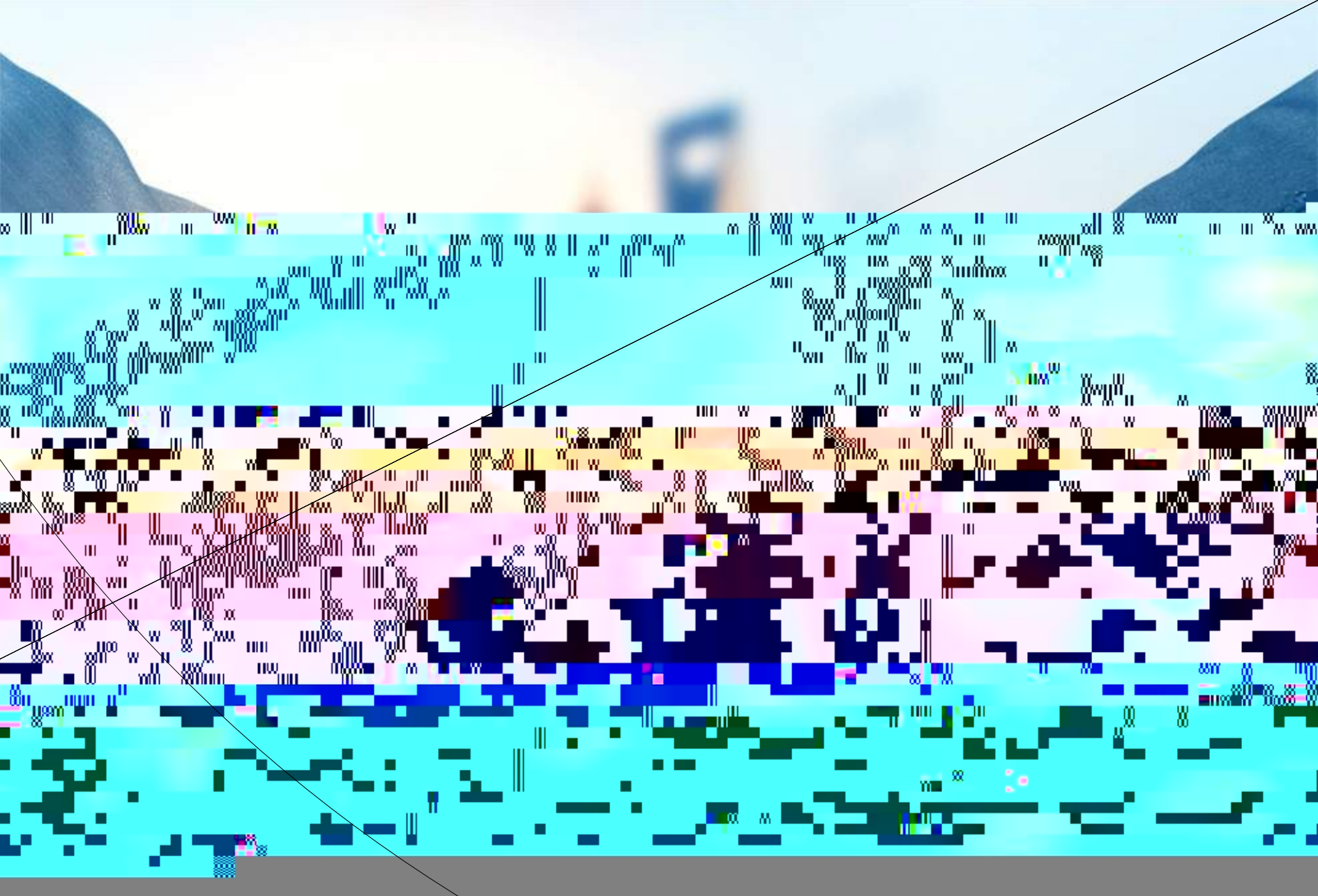
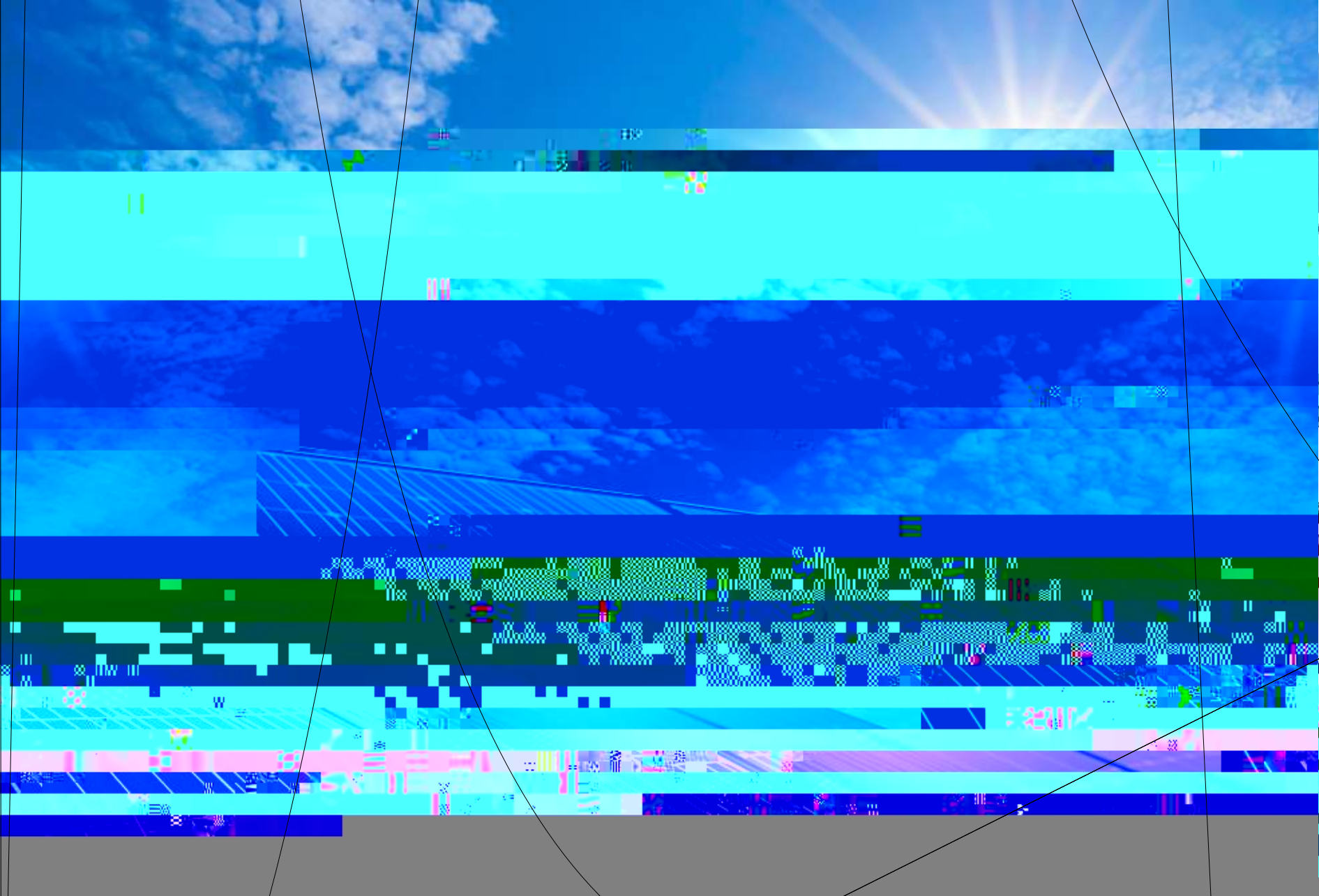





PIP

~~~~

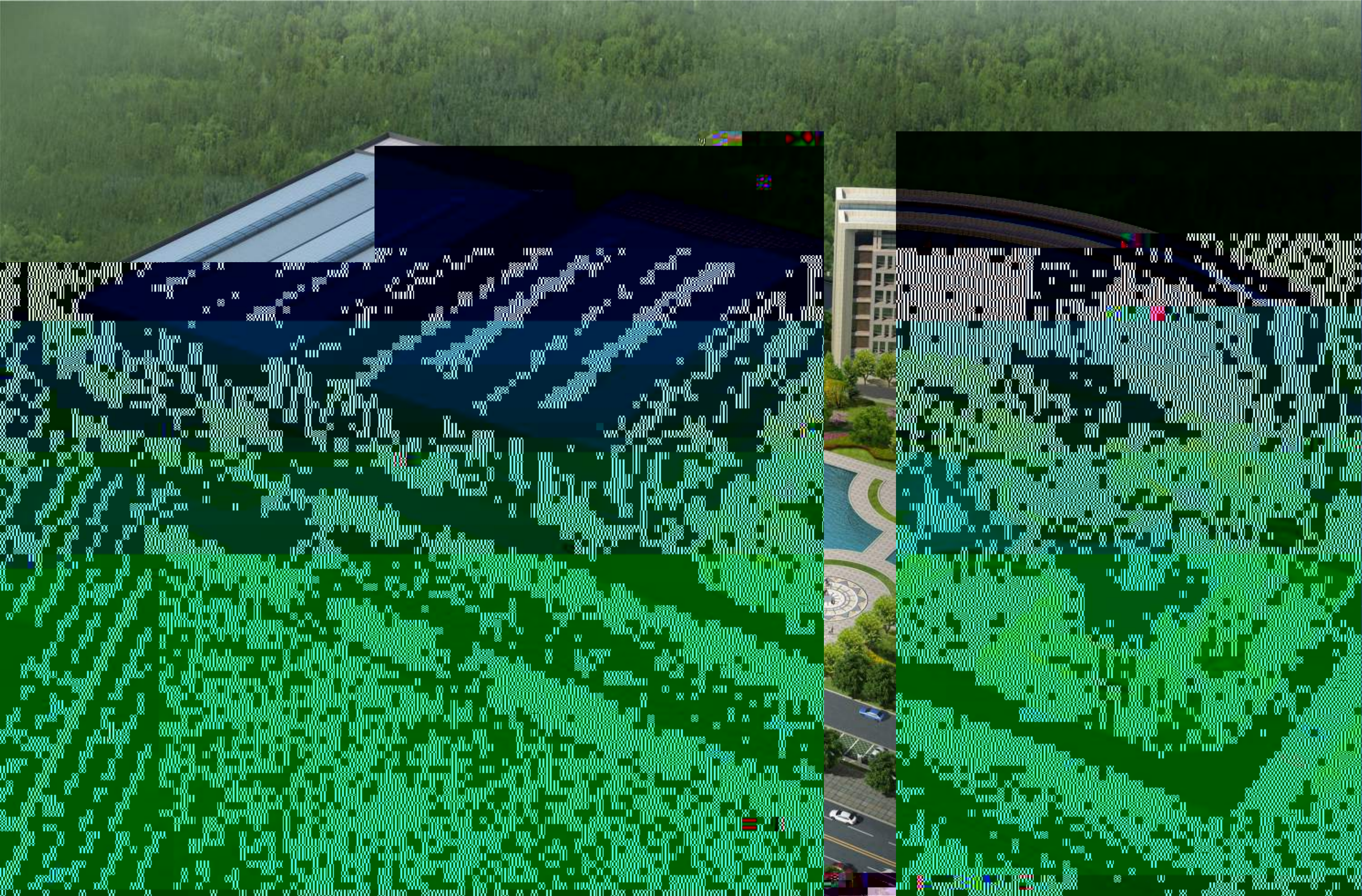



2017

ESCO Danielli Metso

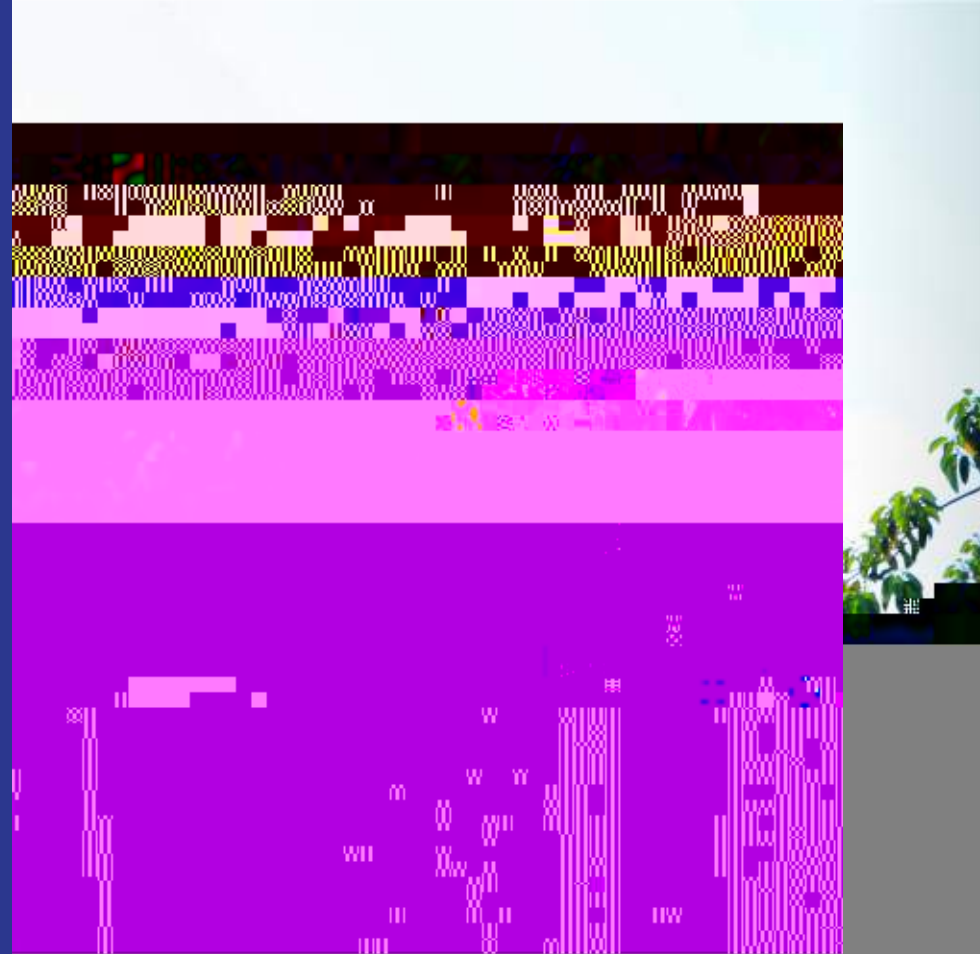
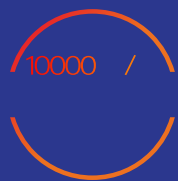
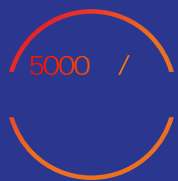
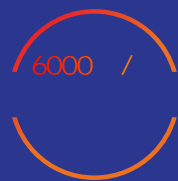

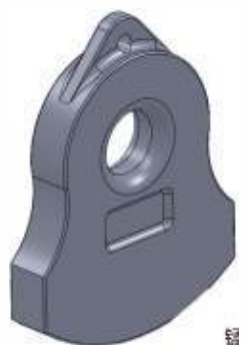
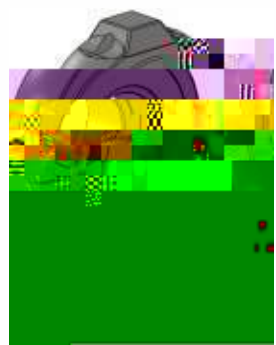

破碎机

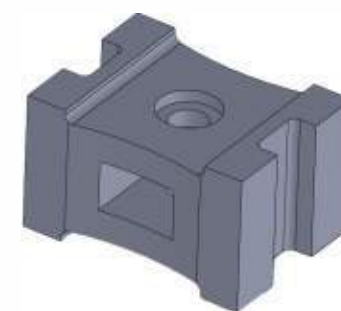
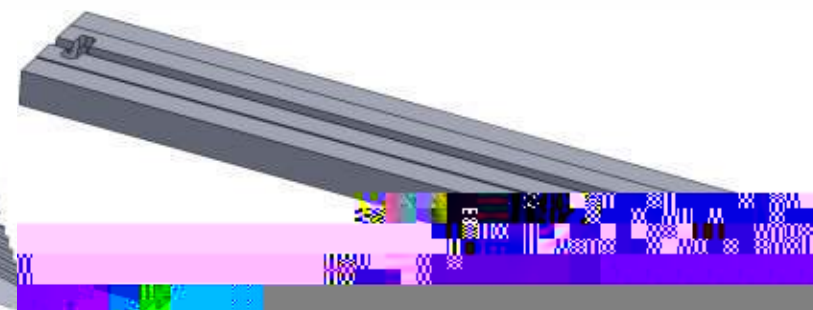
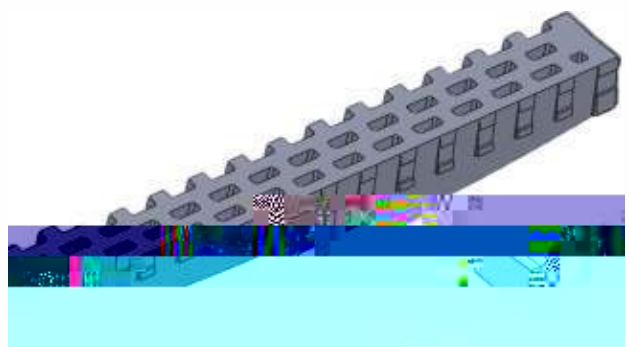

ISO9001  
100%

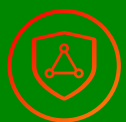

1.5-2

V、Ti



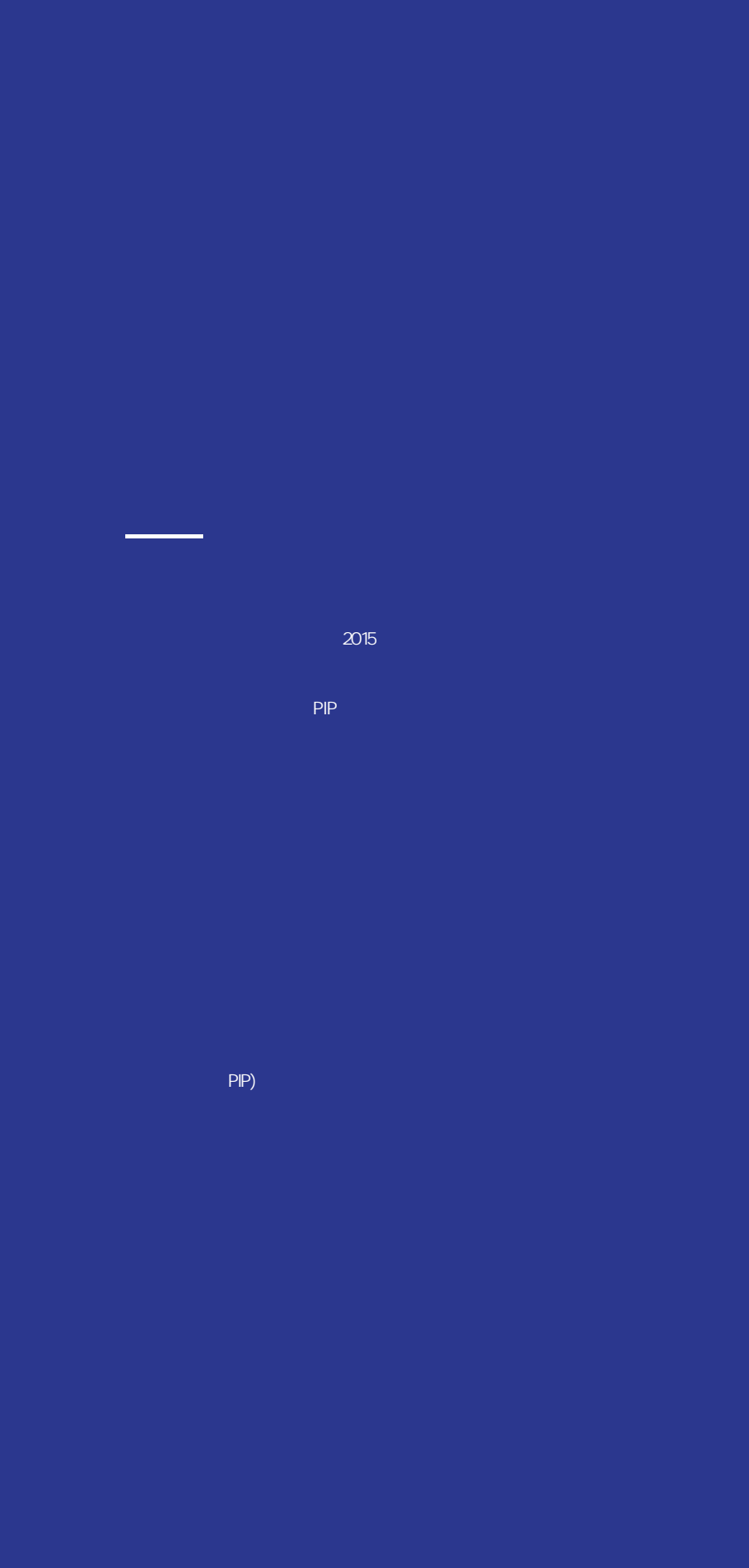

—

2015

PIP

PIP)







中国航天



中船重工



星邦重工 SINOBOOM



鞍钢集团



山西焦煤 SHANXI COKING COAL



长安工业 CHANGAN INDUSTRY



凯卓立



国家能源集团 CHN ENERGY



华润水泥 CR CEMENT



中国石化 SINOPEC



华新水泥 HUAXIN CEMENT



CETC



TISCO



CHINALCO



中国航发南方工业有限公司 AVIC SOUTH INDUSTRY CO., LTD.



中国有色 CHD



ZOOMLION 中联重科



LIUGONG

